

OPERATING AND MAINTENANCE

MANUAL FOR

PPM THECHNOLOGIES

COATING DRUM

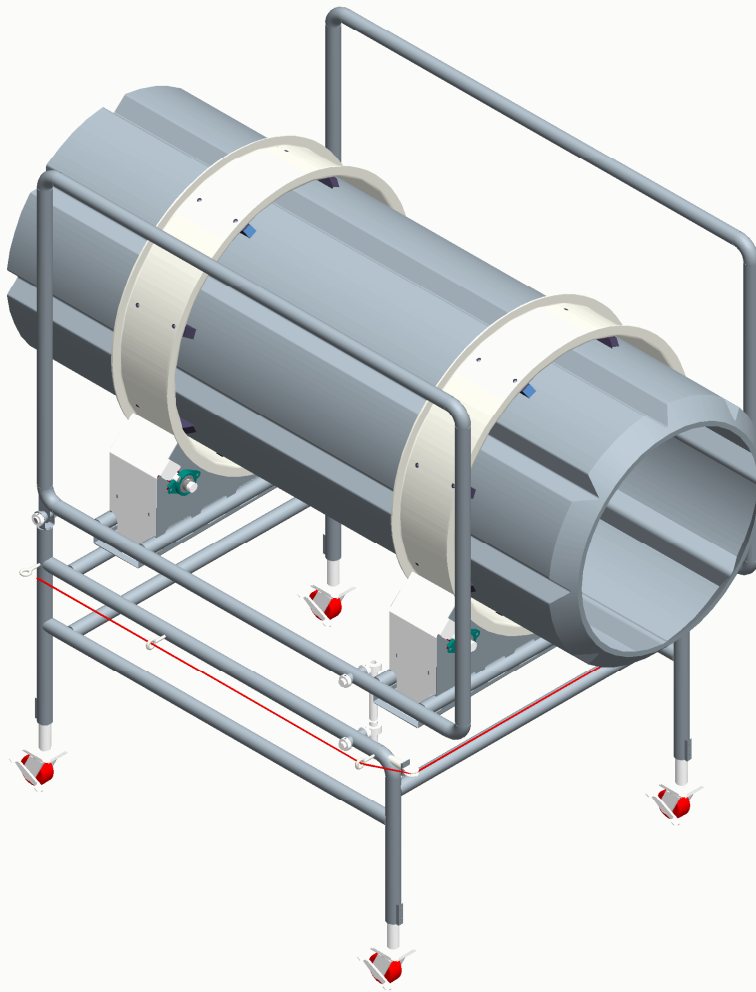



PPM Contact Information:

AMERICAS

PPM TECHNOLOGIES
500 E. Illinois St.
Newberg, OR 97132 | USA
(800) 523-8123 toll free in the US
(503) 538-8575 fax

EUROPE|MIDDLE EAST|AFRICA

PPM AB
Box 288 | SE-291 23
Kristianstad, SWEDEN
+46 44 20 40 00
+46 44 20 44 20 fax

ASIA

PPM TECHNOLOGIES
3/F Taiseido Bldg
2-4-7 Hongo
Bunkyo-ku | Tokyo 113-0033
JAPAN
+81 3 5842 3031
+81 3 5842 3030 fax

Webpage: www.ppmtech.com
Email: Parts.na@ppmtech.com

Printed in the USA

Manual Revision Log

REV #	DATE	CHANGE DESCRIPTION	PG # MODIFIED	BY
1	10/8/08	Updated FMC to PPM	ALL	KN

PPM Technologies reserves the right to alter at any time, without notice and without liability or other obligations on its part, materials, equipment specifications, and models. PPM Technologies also reserves the right to discontinue the manufacturing of models, parts, and components thereof.

TABLE OF CONTENTS

SECTION	DESCRIPTION	PAGE No.
1.	INTRODUCTION AND DRUM INSTALLATION	4
1.1.	Introduction	4
1.2.	What is the Rotating Drum?	4
1.3.	Safety First	5
1.4.	Required Tools	7
1.5.	Lifting Requirements	7
1.6.	Uncrating the Drum	7
1.7.	Installing the Drum	7
1.8.	Finding the Right Drum Angle and Speed	
2.	USING AND MAINTAINING THE DRUM	8
2.1.	Drum Control Panel	8
2.2.	Starting Up	9
2.3.	Shutting Down	9
2.4.	Cleaning and Sanitizing	9
2.5.	Maintenance	10
2.5.1.	Chain Tension and Alignment:	10
2.5.2.	Lubrication	10
2.5.3.	Preventative Maintenance	12
3.	TROUBLESHOOTING	14
3.1.	Common Problems and Cures	14
4.	WARRANTY INFORMATION	15
5.	RETURN MERCHANDISE PROCEDURE	15
6.	RECOMMENDED SPARE PARTS	16
7.	RECORDS - MODEL NUMBER INFO.	
8.	GENERAL NOTES	16
9.	LOST OR DAMAGED GOODS	17
APPENDIX A	CAP SCREW IDENTIFICATION	18
APPENDIX B	RECOMMENDED TORQUE VALUES	19

PPM Technologies reserves the right to make changes to the design, materials, and specification of the equipment described in this document without obligation to notify any person or organization of the revision of change. PPM Technologies Allen Systems further reserves the right to discontinue the manufacture and sale of any components described in this document.

1. INTRODUCTION AND DRUM INSTALLATION

1.1. INTRODUCTION

This book shows you how to install, use, clean and maintain the rotating drum equipment. It contains these chapters:

- Introduction and drum installation (this chapter), which describes the manual, introduces you to the rotating drum and describes how to install and set up the drum on your assembly line.
- Using and maintaining the drum, which describes daily use and cleaning of the equipment. There are no routine maintenance tasks for the drum.
- Troubleshooting, which provides troubleshooting information.

The rotating drum is one of several pieces of equipment that can make up an applicator system. Each separate piece has its own book or booklet. Your system may include one or more of these manuals as well:

- Continuous Oil Applicator Installation Guide and the Continuous Oil Applicator User's Guide if you purchased a continuous oil applicator.
- Seasoner Applicator Installation Guide and Seasoner Applicator User's Guide if you purchased a hopper and seasoner applicator bar.
- Documents from third-party manufacturers who supply items such as motors, blowers, and pumps for your system.

1.2. WHAT IS THE ROTATING DRUM?

The rotating drum is a horizontal drum that rotates so product is distributed evenly around its surface. This allows coatings and seasonings to be applied evenly and consistently. It works with other parts of the Allen Systems' applicator equipment, such as the seasoner bar and the continuous oil applicator.

1.3. SAFETY FIRST

WARNING

Improper use or maintenance of the rotating drum is a safety hazard. Operators, maintenance workers, and all other nearby persons must carefully observe all precautions marked on the equipment or mentioned in this book. Failure to observe the proper safety precautions can result in serious personal injury, electric shock, or death.

WARNING

In the event that repair to the conveyor is necessary, take immediate corrective action to avoid possible injury to personnel and further damage to the conveyor.

General safety precautions include:

- Turn off or disconnect all electrical power before working on the drum. Failure to do so can result in an electrical shock hazard.
- All electrical work must be performed by a licensed, qualified electrician and comply with all applicable electrical codes.
- Turn off any electrical or air-operated accessories and other devices near the applicator equipment. Such devices are often triggered by automatic sensors. If left powered, they might activate unexpectedly, causing injury.

Engineering Staff (503) 538-3141
Parts department (800) 523-8123
Field service (800) 523-8123

PPM Technologies
Customer Service Department
500 E. Illinois Street
Newberg, Oregon 97132

Carefully read this entire manual before operating this machine.

PLEASE RECOGNIZE ALL WARNING STICKERS AND OBEY ANY SAFETY INSTRUCTIONS
WARNING STICKERS ARE PLACED FOR YOUR SAFETY – PLEASE DO NOT REMOVE

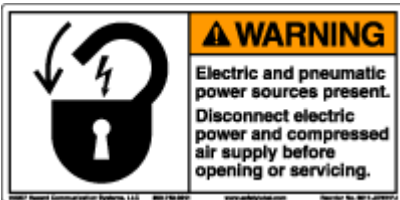

1.4. REQUIRED TOOLS

No tools are required for installation.

1.5. LIFTING REQUIREMENTS

CAUTION

You must be able to lift at least 50 pounds to install the drum.

1.6. UNCRATING THE DRUM

The drum crate includes a Pick List that lists out all the parts that are shipped with each piece of equipment.

NOTE: Before you remove the equipment from the crate, inspect the crate carefully for shipping damage. Report any shipping damage to the freight carrier immediately.

To uncrate the drum:

1. Remove the equipment from the crate.
2. Compare each part against the Pick List, to see if all parts are in the crate.
3. Identify each part by using the custom drawings included with your system to help.
4. Inspect each part carefully for damage. Note any damaged parts by part number.
5. Report any damaged or missing parts immediately.

1.7. INSTALLING THE DRUM

The rotating drum comes completely assembled on casters, ready to place on the production line.

To install the drum:

1. Simply roll it to the area on the production line where the product is to be coated.
2. Place it in position on the line.

NOTE: Product feed into and out of the drum is a customer responsibility.

1.8. FINDING THE RIGHT DRUM ANGLE AND SPEED

How well base product moves through the drum and how well it is coated depends a great deal on the right drum speed and drum angle. You must test to find the right speed and angle for each base product that will run through the drum.

- The drum speed varies from 0 to 16 rpm. Usually, 8-10 rpm is best. The drum speed is correct when there is a rolling effect in the base product, and it moves from the bottom of the bed of product to the top again and again as it moves through the drum.

- Change the drum speed by changing the speed potentiometer on the control panel.

The drum angle varies and is shown by the angle indicator. The correct angle is the one that coats base product evenly and correctly.

- If the product does not have enough coating, make the angle less.
- If the product has too much coating, make the angle more.

Change the drum angle using the jack screws on each side of the drum.

1. Loosen the lock nut on the lower side of the jack screw.
2. Turn the adjusting nut on top of the jack screw to adjust.
 - Turning the adjusting nut clockwise decreases the angle and allows more coating to be applied.
 - Turning the adjusting nut counter-clockwise increases the angle and allows less coating to be applied.
3. Run a trial for each base product that will go through this drum.
4. Write down the drum speed and the drum angle for each product.
5. Keep this information near the drum. It will be needed each time the product on the line changes.

2. USING AND MAINTAINING THE DRUM

The rotating drum is a simple piece of equipment. Once it is rolled into place onto the assembly line and product feed into and out of the drum is established, you are ready to run product.

You can also install a continuous oil applicator or a seasoner bar into the drum to apply coatings and seasonings to products running through the drum.

To run the drum:

Stop and start the drum as needed to coat the product.

Many drums are controlled by automatic stop/start equipment, such as a photoelectric eye. Installation, connection and maintenance of automatic stop/start equipment is not covered in this book. See the manufacturer's instructions.

2.1. DRUM CONTROL PANEL

Drums come with either a control panel of their own, or as part of a complete system with a combined control panel. If your drum has its own control panel, follow the directions in this chapter for starting and stopping the drum.

2.2. STARTING UP

WARNING

Be sure that no one and nothing is touching the drum before starting. Serious injury can occur if clothing, arms, hands, electrical wires, and other items are caught between the drum and the frame when the drum starts up.

To start the drum after making sure that the drum is clear:

1. Pull the red emergency STOP (E-Stop) button out.
 - If you are using automatic start/stop equipment to control the drum, turn the control to AUTO.
 - If you are manually stopping and starting the drum, turn the control to ON.
2. Push the START button.
 - If you are using the continuous oil applicator or the seasoner bar, turn this equipment on once product has started moving through the drum.

NOTE: Never spray in an empty drum.

2.3. SHUTTING DOWN

CAUTION

Shut off the continuous oil applicator or the seasoner bar before shutting off the drum, if you use them.

To shut off the drum:

Press the STOP button and turn the control to OFF.

2.4. CLEANING AND SANITIZING

WARNING

Always shut off the drum and turn off the main breaker before cleaning or maintaining the drum. There is a risk of electric shock, especially if spraying liquids in or on the equipment. Follow your plant's standard procedures for cleaning and sanitizing equipment on the line. Drums are made of polyethylene or stainless steel and can tolerate water or cleaning solution temperatures high enough to properly sanitize.

NOTE: Be sure the drum and frame are thoroughly dry before starting up again.

2.5. MAINTENANCE

2.5.1. Chain Tension and Alignment:

Chain Tension should be adjusted to allow ½” to 1” of movement between the sprockets.

Replace Chain Guard after adjusting chain tension. Use a straightedge to align sprockets. Make sure the setscrews are tight when finished.

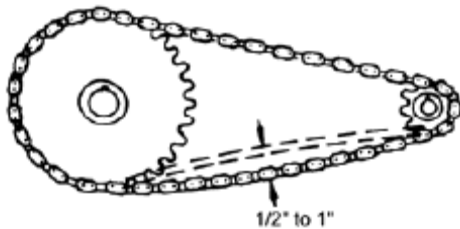

2.5.2. Lubrication

Shaft Bearings

The shaft support bearings are greased during assembly at the factory and should require no additional grease prior to start-up.

Grease every 1000 hours, which computes to every six months at 8 hours daily operation or two months at 24

hours daily operation. Harsh daily washdown areas may require bearing lubrication more frequently (once a week).

DO NOT OVER GREASE. Too much grease or under too much pressure will rupture the seals, reducing the life of the bearings. Use any good quality gun type grease. Apply until a very slight bead appears around the bearing seal.

Chain

Lubricate every 500 hours, which computes to every 3 months at 8 hours daily operation and every month at 24 hours daily operation. To extend chain life, apply two drops of oil between the link side plates on each side of the chain at each roller using a good quality food grade mineral oil.

Speed Reducer & Motor

Speed reducers used by PPM Technologies are properly filled at the factory with sufficient lubrication. Most gear manufactures recommend that the oil be changed using good quality gear oil after the initial 250 hours of operation, and thereafter at regular intervals of 2500 hours or every 6 months. If synthetic oil is being used, it is recommended that the oil be changed after the initial 1500 hours of operation, and thereafter at regular intervals of 5000 hours. Change the oil when performing maintenance that requires gearbox disassembly

If your machine is equipped with a Dodge/Reliance gear reducer with the Relialube system, the break-in period and subsequent oil change ordinarily experienced with conventional reducers has been eliminated. No oil needs to be added at installation. The oil needs to be changed only after the unit has been put into service at regular intervals of 5000 hours.

PPM Technologies recommends using synthetic oil Mobil SHC-634. If re-lubrication of the input bore is required use Fel-Pro CSA Antisieze or Mobiltemp 78 grease in the bore and on the motor shaft. A food grade lubricant may be supplied at customer's request. If you need assistance determining the correct lubricants to use in a particular application, contact the PPM Technologies Allen Systems customer service department.

The bearings in the motor are greased during manufacturing, but require periodic maintenance. Motor manufactures usually recommend that the bearings be lubricated with grease at regular intervals of 12,000 hours or every 12 months of operation.

2.5.3. Preventative Maintenance

Mechanical Maintenance:		
Item	Schedule	Service
Motor and Gear Reducer	At Start-up and 100 Hours After 250 Hours After Very 2500 Hours	Check Oil Level Change Oil and Check Oil Level at Regular Intervals Change Oil
Roller Chain	200 Hours 500 Hours	Check Tension at Regular Intervals Clean and Lubricate with Brush or Spray
Flange Bearing	1000 Hours	Lubricate
Sealed for Life Bearing (End Take-up pulleys, Snubber and Return Rollers)	Monthly	Check for Unusual Noise or Excessive Wear, Replace as Required
<p>Note:</p> <p>Gear Reduction Drives Supplied With PPM Drum Units Are Filled With Lubricant Prior To Shipping. The Lubricant Level Should Be Checked Prior To Start-Up and the Breather Plug Installed in the Proper Location (See Reducer Manual Supplied With Unit) Only Refill Reducers With The Approved Lubricant (Synthetic Compound) Standard Service Only - If Service Is More Severe, The Oil Should Be Changed More Frequently. Consult The Reducer Manufacturer For A More Specific Lubrication Schedule.</p>		
<p>Electrical Maintenance:</p> <p>WARNING: DISCONNECT ALL POWER BEFORE PERFORMING THE FOLLOWING MAINTENANCE.</p> <p>ONLY A QUALIFIED ELECTRICIAN OR AN ELECTRICAL TECHNICIAN SHOULD PERFORM THE FOLLOWING MAINTENANCE.</p>		
Control Panels and Pushbutton Enclosures	Always 100 Hours and 2000 Hours Check if components have Vibrated Loose	Enclosures should be Clean and Dry Check if components have Vibrated Loose Check Door/Power interlocks and Latches Check for Loose or Discolored Wires

	At Start-up, Monthly or if any problems Occur.	(Discolored Wires Indicate an Excessive Current Draw)
Limit Switches	100 Hours and 2000 Hours	Check Arms for Adjustment and Tightness
Pushbuttons	100 Hours and 2000 Hours	Check Wires and Terminals for Tightness
Emergency Stop Devices	100 Hours and 2000 Hours	Check for Proper Operation
Conduit and Conduit Hangers	2000 Hours	Check for alignment and Damage, Exposed Wiring
Wiring	At Start-up, Monthly or if any problems Occur.	Check for Exposed Cords and Wires for Damage, Replace as Necessary

Note:

A Qualified Electrician Or Electrical Technician Should Keep A Log Book Of The Following Readings with any Excessive

Deviation from Normal, Signals a Problem Area.

1. Measure Voltages And Current Of Incoming Power To Enclosure
2. Measure Current Readings Of All Motors
3. Measure Current Readings On Primary And Secondary of Control Transformer To Insure Proper Voltage.

Review Spare Parts:

Review Usage - Excessive Use of Fuses Or Replacing The Same Part Several Times Indicates an Excessive Current Draw,

Faulty Components or Exceeding The Capacity of the Conveyor Unit.

3. TROUBLESHOOTING

DO NOT ATTEMPT MAINTENANCE ON ANY DRUM WHILE IT IS IN OPERATION

3.1. COMMON PROBLEMS AND SOLUTION

Problem	SOLUTION
<p>Motor will not run or drum is not rotating</p>	<ol style="list-style-type: none"> 1. There is no power. Check that all electrical connections have been made correctly and that the main power is ON. 2. The fuse or motor starter protector has failed. Replace the fuse or protector. Check the system to see why it failed and correct any electrical problem. 3. The DC or AC drive has failed. Refer to the manufacturer's data manual for more information. 4. The low-powder sensor timed out and the bypass was turned off. Turn the bypass on.
<p>Product is not coated enough even though the amount being applied is correct according to the flow curve</p>	<p>The drum is not angled enough. Increase the angle.</p>
<p>Product is coated too much even though the amount being applied is correct according to the flow curve</p>	<p>The drum is not angled enough. Increase the angle.</p>
<p>Product bed width is wider at the discharge than at the infeed</p>	<p>The drum is angled too much. Decrease the angle.</p>
<p>Product bed width is narrower at the discharge than at the infeed</p>	<p>The drum is angled too much. Decrease the angle.</p>

4. WARRANTY INFORMATION

PPM Technologies' warranty is available only to the original purchaser of this equipment and applies only to defects in material and workmanship for a period of one (1) year from the date of shipment. There are no other warranties, which extend beyond the description of the goods at the time of sale, and no other warranties may be deemed made by or implied against PPM Technologies.

In addition, PPM Technologies' liability is limited to the repair or replacement, at its option, of any defective goods F.O.B. its place of business at Newberg, Oregon. PPM Technologies shall in no event be liable for any special, incidental or consequential damages, or loss of product/production resulting from any defect in goods sold by it.

Unauthorized modifications or the use of unauthorized replacement parts may damage the machine. Use only PPM Technologies approved replacement parts. PPM Technologies will not assume responsibilities for equipment performance subsequent to unauthorized modifications or the use of unauthorized replacement parts. When ordering replacement parts, including all information shown on conveyor nameplate.

5. RETURN MERCHANDISE PROCEDURE:

Have part number and purchase order ready.

Call PPM Parts Department @ 800-523-8123 obtains RMA #.

PPM Parts Department will not be able to tell you if the parts are under warranty, as they need to inspect the parts.

Although your parts may be less than one year old, it depends on the type or cause of failure and may not be under warranty.

PPM Technologies Allen Systems reviews failures and determines if the parts are under warranty.

Send parts back to: PPM Technologies

500 E. Illinois St.

Newberg, Oregon 97132

RMA#

Items returned w/o RMA # will NOT BE ACCEPTED and will be sent back to customer.

Once parts are repaired they will be sent back to our customer VIA:

UPS ground (5 days) unless otherwise arranged.

The information in this publication is intended to cover a variety of installations and requirements. It is to be expected that situations will arise that have not been adequately covered by the foregoing data and should difficulties arise please contact your local representative of PPM Technologies who will assist you to obtain a satisfactory installation or contact the PPM Service Department at the above number.

6. RECOMMENDED SPARE PARTS

We recommend that you carry in stock a minimum quantity of spare parts for your PPM conveyor. Please be sure to specify Model Number of conveyor when ordering parts. It is recommended that you stock the following parts for every THREE machines on site.

PART	QUANTITY
Motor & gearbox	(1) Per Machine
Bearing	(1) Set Per Machine
Drive sprockets	(1) per Machine

There may be included with this manual, a custom recommended spare parts list, and drawings specific to your PPM equipment. When ordering parts for any machine, please specify model number shown on serial number tag when ordering parts.

7. ADD YOUR DRUM INFORMATION HERE FOR FUTURE REFERENCE

NOTE: THE PPM TECHNOLOGIES MODEL NUMBER IS THE MOST HELPFUL INFORMATION FOR IDENTIFICATION

MODEL NO:- _____
SERIAL NO:- _____
DESCRIPTION: - _____

8. GENERAL NOTES

The information in this publication is intended to cover a variety of installations and requirements. Situations may arise that have not been adequately covered by this manual. Should you require further assistance, please contact PPM Technologies to assist you in obtaining a satisfactory installation.

PPM Technologies would also appreciate any comments on the documentation received. Addresses and phone numbers are on page #2 of this manual.

To protect your warranty, contact our factory prior to any modifications.

9. LOST OR DAMAGED GOODS:

THOROUGHLY INSPECT AND COUNT ALL SHIPMENTS IMMEDIATELY UPON ARRIVAL. OUR RESPONSIBILITY FOR ALL SHIPMENTS IS CEASED WHEN THE CARRIER SIGNED THE BILL OF LADING.

If goods are received short or in a damaged condition, it is important that you notify the carrier and insist on a notation of the loss or damage across the face of the freight bill; otherwise no claim can be enforced against the transportation company.

If concealed loss or damage is discovered, notify your carrier at once and request an inspection. This is absolutely necessary. A concealed damage report must be made within 15 days of delivery of shipment. Unless you do this, the carrier will not entertain any claim for loss or damage. The agent will make an inspection and grant a concealed damage notation. If you give the Transportation Company a clear receipt for goods that have been lost in transit, you do so at your own risk and expense.

We are willing to assist you to collect claims for loss or damage, but this willingness on our part does not make us responsible for collection of claims or replacement of material. The actual filing and processing of claims is your responsibility.

* If your shipment is crated or wrapped, you should sign the Bill of Lading noting "subject to Concealed Damages".

APPENDIX A

CAPSCREW IDENTIFICATION



SAE Grade 1 / SAE Grade 2 / ASTM A307 (unacceptable)

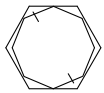

SAE Grade 3 (unacceptable)

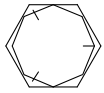

SAE Grade 5 / ASTM A449 (acceptable)



ASTM A325 (acceptable)



ASTM A354 Grade BB (acceptable)



ASTM A354 Grade BC (acceptable)

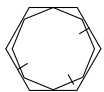

SAE Grade 5.1 (acceptable)



ASTM A193 Grade B7 (acceptable)

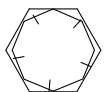

SAE Grade 7 (acceptable)

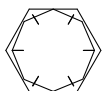

SAE Grade 8 (acceptable)



ASTM A490 (acceptable)

APPENDIX B

RECOMMENDED TORQUE VALUES

**S.A.E. GRADE 5
 TORQUE**

**S.A.E. GRADE 8
 TORQUE**

BOLT SIZE	DRY (FT. LBS.)	LUBRICATED OR PLATED (FT. LBS.)	DRY (FT. LBS.)	LUBRICATED OR PLATED (FT. LBS.)
1/4-20	8	6	12	9
1/4-28	10	8	14	10
5/16-18	17	13	24	18
5/16-24	19	15	27	20
3/8-16	30	23	45	34
3/8-24	35	27	50	38
7/16-14	50	38	70	53
7/16-20	55	42	80	61
1/2-13	75	57	105	80
1/2-20	85	65	120	91
9/16-12	110	84	155	118
9/16-18	120	91	170	129
5/8-11	150	114	210	160
5/8-18	170	129	240	182
3/4-10	270	205	375	285
3/4-16	300	228	420	320
7/8-9	430	327	610	464
7/8-14	475	361	670	509
1"-8	645	490	910	692
1"-12	705	535	1000	760
1"-14	720	547	1015	771